

**ZEVEEX**<sup>®</sup>  
Enteral Nutrition Delivery Systems



◀ **Actual User**  
(see page iii  
for details)

**EnteraLite**<sup>®</sup> **Infinity**<sup>∞</sup>  
ENTERAL FEEDING PUMP

---

# TABLE OF CONTENTS

	Page
<b>TABLE OF CONTENTS</b> .....	<b>i</b>
<b>PRODUCT OVERVIEW</b> .....	<b>iii</b>
<b>LIST OF WARNINGS AND CAUTIONS</b> .....	<b>iv</b>
<b>1. PUMP COMPONENTS</b> .....	<b>1</b>
EnteraLite Infinity Enteral Feeding Pump .....	1
Keypad .....	3
Display .....	4
Disposable Set .....	5
Symbols .....	6
<b>2. DIRECTIONS FOR USE</b> .....	<b>7</b>
Priming and Loading the Disposable Set .....	7
Operating the Pump	
A Single Feeding Example .....	10
An Interval Feeding Example .....	13
The Battery	
Running on Battery Power .....	17
Charging the Battery .....	18
User Preference Settings .....	19
<b>3. ALARMS, MESSAGES, AND INDICATIONS</b> .....	<b>21</b>
<b>4. TROUBLESHOOTING GUIDE</b> .....	<b>28</b>
<b>5. CLEANING</b> .....	<b>31</b>
<b>6. ACCESSORIES</b> .....	<b>32</b>
<b>7. SPECIFICATIONS</b> .....	<b>34</b>
<b>8. IMPORTANT PEDIATRIC CONSIDERATIONS</b> .....	<b>36</b>
<b>9. ADDITIONAL TECHNICAL INFORMATION</b> .....	<b>37</b>
<b>10. WARRANTY</b> .....	<b>39</b>
<b>LIST OF FIGURES</b> .....	<b>40</b>
<b>WHO TO CALL</b> .....	<b>43</b>
<b>INDEX</b> .....	<b>45</b>



---

## PRODUCT OVERVIEW

The EnteraLite® Infinity® is a rotary peristaltic enteral feeding pump designed to deliver programmed doses of enteral nutrition solutions at selectable rates. It is easy to use with a simple user interface and keypad. ZEVEX technology allows an accuracy rate of +/- 5% and the ability to safely operate in any orientation. The EnteraLite Infinity system includes a complete line of DEHP-free pump delivery sets with automatic free-flow protection.

The EnteraLite Infinity is designed for both hospital and alternate care use. It is durable, water resistant, and easily carried in a ZEVEX carry pack. The EnteraLite Infinity's size, weight, accuracy, and portability promote and support health improving physical activity.

### Cover Image

Actual user, 9 year-old Kendall Hollinger. 2005 ISI World Champion Figure Skater. 2004 ISI California State Champion Figure Skater. For more information on Kendall, contact Kim Hollinger at [ibtaxi2ice@aol.com](mailto:ibtaxi2ice@aol.com).

---

# LIST OF WARNINGS AND CAUTIONS

## WARNINGS

- ▶ Use ONLY feeding solutions prescribed by the responsible physician, registered dietitian, registered nurse, or other licensed practitioner.
- ▶ Use ONLY EnteraLite Infinity Disposable Sets to ensure proper fluid delivery. Others will not deliver the correct dose, may allow dangerous free-flow conditions, and may generate hazardous fluid pressures which may activate occlusion alarms at unpredictable pressures.
- ▶ Low flow rates, combined with high dose settings may exceed the life of the disposable set. The disposable set must be replaced every 24 hours to maintain delivery accuracy, allow proper air and occlusion sensing, and prevent growth of bacteria. **DO NOT PROGRAM RATE AND DOSE COMBINATIONS WHICH EXCEED A 24 HOUR FEED REGIMEN.**
- ▶ The battery capacity is an approximation. If you are unsure that enough capacity remains for your intended use, recharge it.
- ▶ To avoid electrical shock, never clean pump with charger plugged into an outlet or when pump is on.
- ▶ Make sure the EnteraLite Infinity AC Adapter/Charger is completely dry before plugging into an electrical outlet.
- ▶ Do not use EnteraLite Infinity Enteral Feeding Pump for delivery of non-enteral solutions. Serious injury may result.
- ▶ Proper operation of pump requires door is closed and latched. Make sure door is closed and latched when motor is running.
- ▶ If an error occurs (ER01 - ER99 or ERA - ERZ will appear in display), all settings and volume counters should be checked and verified before starting a feeding.

---

## CAUTIONS

- ▶ Federal law (U.S.A.) restricts this device to sale by or on the order of a physician, registered dietitian, registered nurse, or other licensed practitioner.
- ▶ Dispose of EnteraLite Infinity Disposable Sets properly, as required by local law.
- ▶ If any leaks are detected in the disposable set, stop pump operation and disconnect set from patient and replace with a new disposable set.
- ▶ Care should be used when manually priming delivery set to ensure cassette is not damaged by excess force.
- ▶ Do not overload carry packs with personal items. Pump function may be affected by kinked or pinched tubing and/or unintentional button presses.



# 1. PUMP COMPONENTS

## EnteraLite Infinity Enteral Feeding Pump

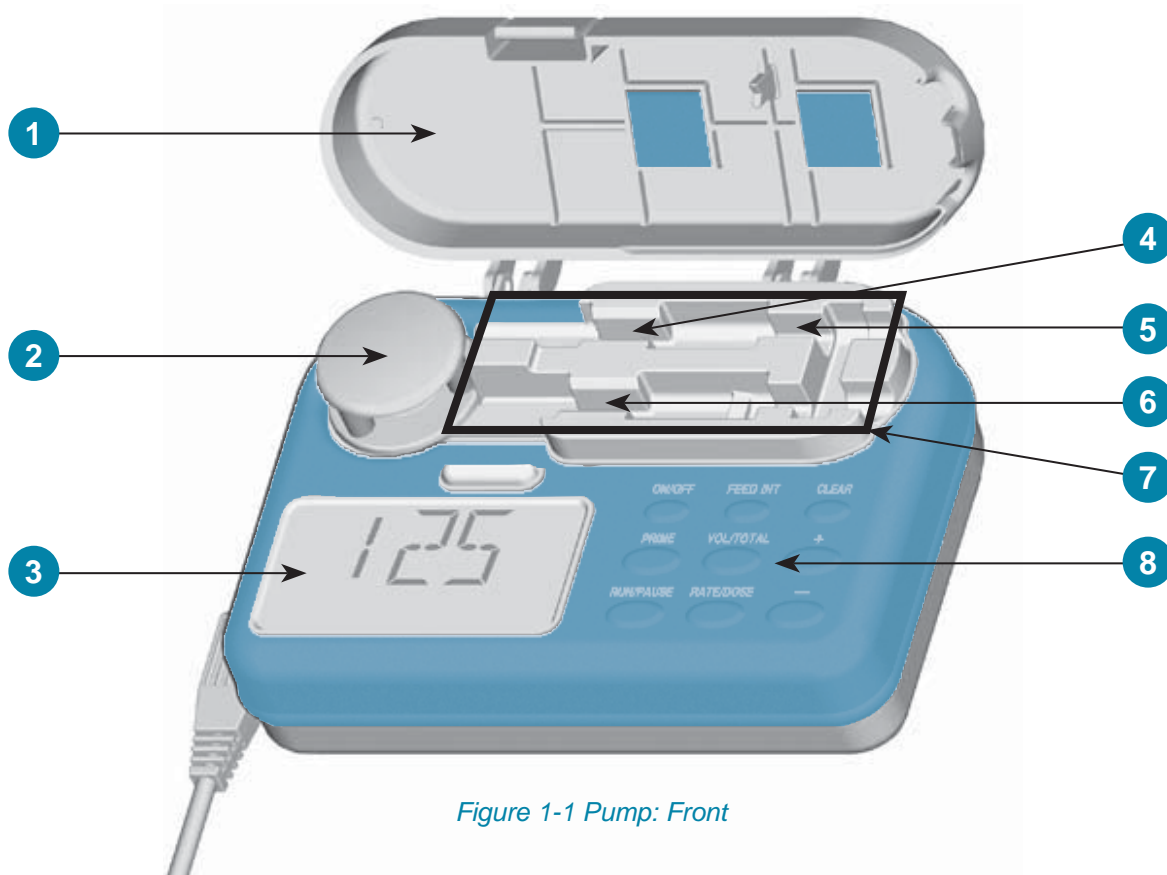

Figure 1-1 Pump: Front

1. Door
2. Pump Wheel
3. Display
4. Upstream Pressure Sensor
5. Air Sensor
6. Downstream Pressure Sensor
7. Receptacle for Cassette
8. Keypad



## EnteraLite Infinity Enteral Feeding Pump

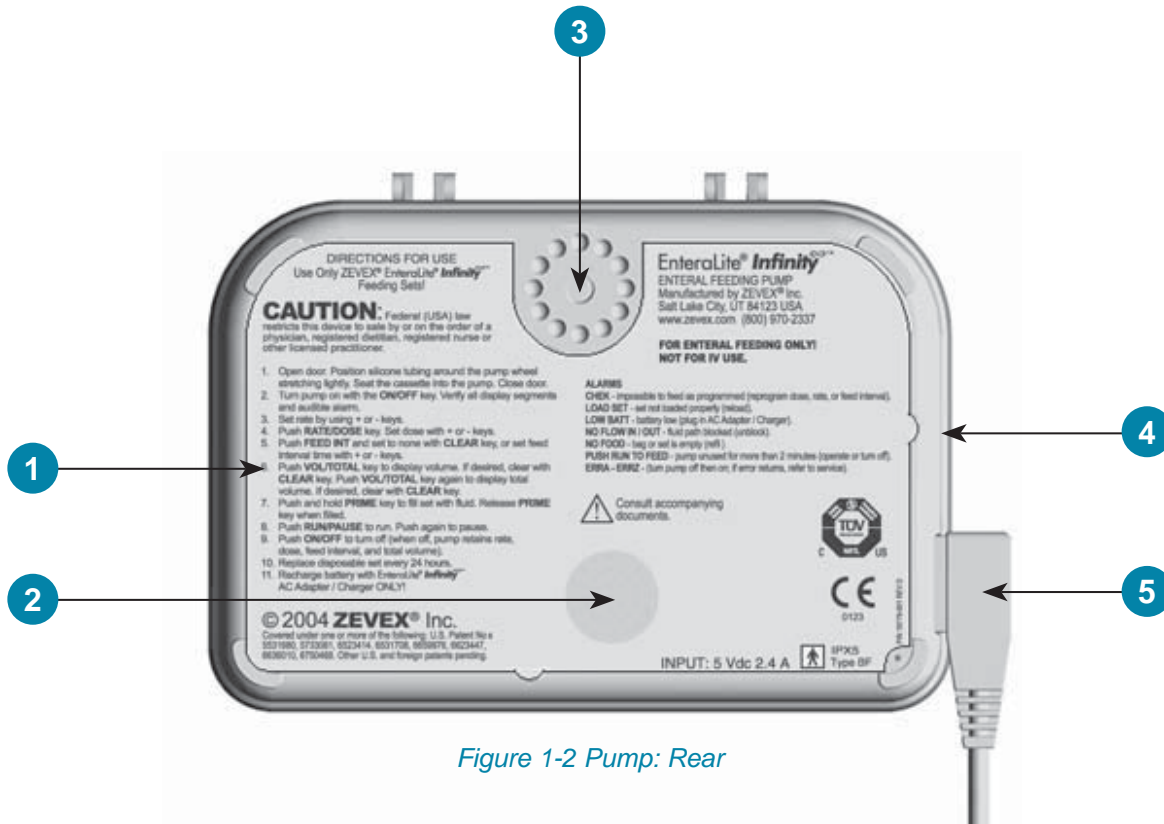

Figure 1-2 Pump: Rear

1. Pump Instruction Label
2. Speaker
3. Receptacle for Pole Clamp
4. Serial Number Label
5. Charger/Power Connector

## Keypad



Press **ON/OFF** key for 1.5 seconds to either turn EnteraLite Infinity on or off.



Press and hold **PRIME** key to rapidly fill disposable set with fluid. Release key to stop.



Press **RUN/PAUSE** key to either start pump or place it in pause mode.



Press **FEED INT** key to display feed interval setting.



Press **VOL/TOTAL** key once to display volume delivered for current feeding. Press key again to display total cumulative volume delivered in all feed cycles since total volume was last cleared.



Press **RATE/DOSE** key to transition between rate and dose settings.



Press **CLEAR** key to reset displayed function to its minimum value. Press and hold for three seconds to clear rate, dose, feed interval and volume delivered to minimum values at the same time.



Press **+** key to increase displayed feed function. Press and hold key to increase value rapidly.



Press **-** key to decrease displayed feed function. Press and hold key to decrease value rapidly.

Note: The following keys only function when pump is in pause mode: **PRIME**, **CLEAR**, **+**, and **-**.

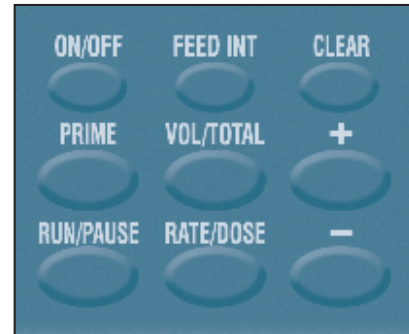

Figure 1-3 Keypad Layout

## Display

The display includes large alphanumeric characters, as well as smaller symbols and words. All segments and symbols on the display are shown in *Figure 1-4*.

Settings and messages are displayed in large alphanumeric characters (*Figure 1-5*).

When the large alphanumeric characters display numbers, one of the smaller words below the characters indicates which function is being displayed (*Figure 1-6*).

The run symbol indicates pump is running (*Figure 1-7*).

The wall plug symbol indicates the charger is plugged in, and connected to a live power outlet. The battery symbol indicates pump is running on battery power only. The fuel gauge symbol indicates how much battery charge remains (*Figure 1-8*).

NOTE: The display light will automatically turn off 10 seconds after the last key is pressed. The light will also remain on for 10 seconds after the charger is connected between pump and live power outlet. If you would prefer the light to remain on when connected to an outlet, you can change the pump light setting to ON. See the User Preference Settings section (*Page 19*) for instructions to change this setting.

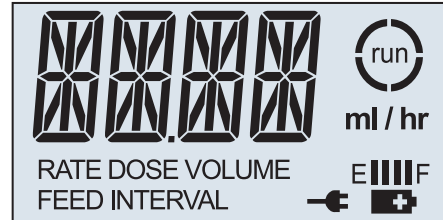

Figure 1-4 Display Segments

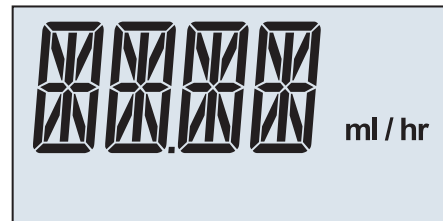

Figure 1-5 Alphanumeric Characters and Units

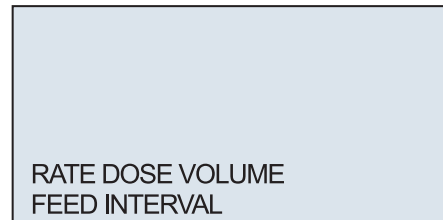

Figure 1-6 Setting Indicators

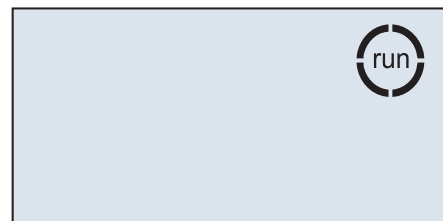

Figure 1-7 Run Indicators

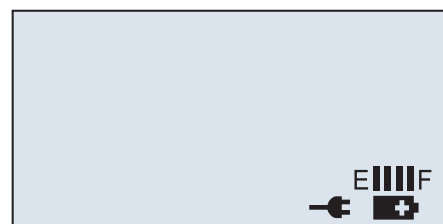

Figure 1-8 Power Indicators

## Disposable Set

The only disposable sets approved for use with EnteraLite Infinity pump are:

- ▶ EnteraLite Infinity 500 ml Bag Set - Order Number INF0500
- ▶ EnteraLite Infinity 1200 ml Bag Set - Order Number INF1200
- ▶ EnteraLite Infinity Spike Set - Order Number INF0010

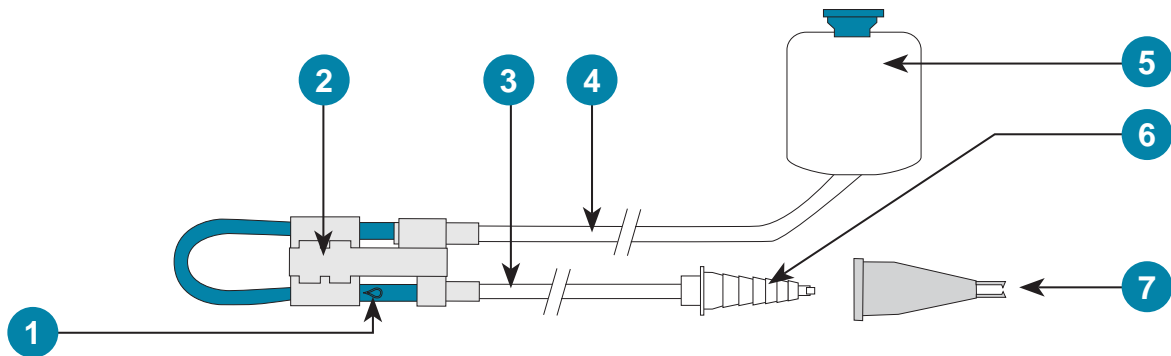

Figure 1-9 EnteraLite Infinity 500ml or 1200ml Bag Set

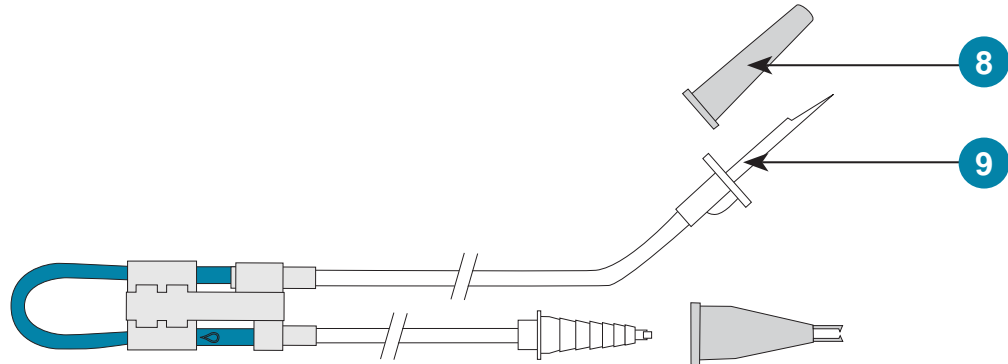



Figure 1-10 EnteraLite Infinity Spike Set

1. “” Symbol
2. Cassette
3. Downstream Tubing
4. Upstream Tubing
5. 500ml or 1200ml Feeding Bag
6. Barbed Enteral Adapter
7. Adapter Protective Cover
8. Spike Protective Cover
9. Spike

## Symbols

Brief instructions for operation of pump as well as a brief explanation of each alarm message which pump may communicate are printed on the label attached to pump. These are not intended to be used in place of the Operator's Manual. They are simply a quick reference guide. Please read the Operator's Manual before operating the EnteraLite Infinity.



Consult  
Accompanying  
Documents

*Figure 1-11 Consult  
Accompanying Documents*

---

The bag symbol is printed on pump door over port where upstream tubing enters pump.



*Figure 1-12  
Feeding Bag Connection*

---

The patient symbol is printed on pump door over port where downstream tubing exits pump.



*Figure 1-13 Patient Connection*

---

EN 60601-1 Type BF degree of protection against electrical shock. No electrical connection to patient. Drop from any angle from height of 3 feet shall not damage pump operation.



*Figure 1-14  
TYPE BF Shock Protection*

---

IEC 529 degree of protection against water entering the enclosure. Water jets from any direction shall have no effect.

**IPX5**

*Figure 1-15 IEC 529*

---

This symbol is printed on pump delivery sets. It indicates only one patient should use each disposable set.



*Figure 1-16 Single Patient Use*

---

This symbol is printed on pump delivery sets. It indicates pump delivery sets are made with materials that do not contain the plasticizer DEHP.



*Figure 1-17 DEHP-free*

## 2. DIRECTIONS FOR USE

### Recommendation for First Use:

Since battery may not be fully charged when pump is first received, it is recommended that battery be charged for 6 hours prior to operating on battery power (see Page 18 for additional information).

### Priming and Loading the Disposable Set

#### Step 1:

- ▶ **If you are using the spike set with a vented bottle or pre-filled bag:**

Remove protective cover from spike, and insert spike into spike adapter of formula container (Figure 2-1).

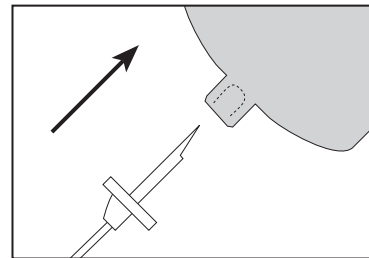

Figure 2-1 Spike Container

- ▶ **If you are using the 500ml or 1200ml disposable set:**

Hold bag upright and pour in feeding solution (Figure 2-2). Close cap securely.

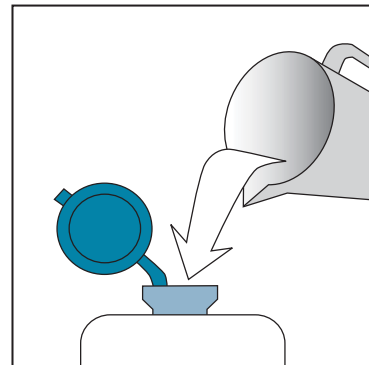

Figure 2-2 Fill Bag

NOTE: Blenderized or aggressively mixed solutions may have foam. If using this type of solution, allow it to sit for 10 to 15 minutes before pouring into bag. This will reduce the chance of an alarm due to air in the tubing.

#### Step 2:

Remove protective cover from barbed adapter. If using pole clamp, protective cover may be placed in the groove on back of clamp (Figure 2-3).

NOTE: If set is to be used with a carry pack, all air must be removed from bag and tubing. **Continue to step 3 for instructions on removing air.** If set is to be hung above pump, i.e. on an IV pole, **you may skip to step 4.**

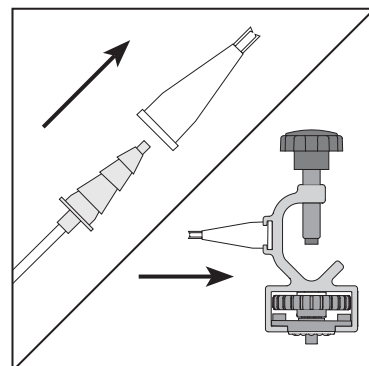





Figure 2-3 Remove Cover from Barbed Adapter / Place Cover on Pole Clamp

### Step 3:

Turn bag upside down and gently squeeze. Tilt bag as needed to keep air at tubing port (*Figure 2-4*).

### Step 4:

Gently pinch teal colored tubing **below** “” symbol. Hold this position until air is removed from tubing. Gently squeeze bag at same time to assist fluid flow. If fluid does not flow, pinch may be too tight (*Figure 2-5*).

NOTE: Inside the teal colored tubing, below the “” symbol is the in-line occluder. The in-line occluder is the built-in anti free-flow device. By pinching tubing gently, the tubing moves away from the in-line occluder allowing fluid to flow (*Figure 2-6*). It is important to only pinch the tubing below the “” symbol to avoid damaging the in-line occluder.

NOTE: Air may also be removed from tubing using the pump prime feature. See step 7 for instructions on using the pump prime feature.

### Step 5:

Loop silicone tubing around pump wheel stretching lightly. Seat cassette into pump (*Figure 2-7*). **Close pump door** (*Figure 2-8*).

NOTE: If 1200ml set is to be used with Mini Backpack, load set into back section of pack and thread cassette through port in bottom corner of pack prior to loading cassette into pump.

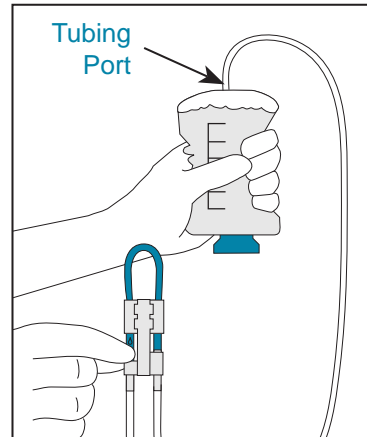

Figure 2-4 Squeeze Bag

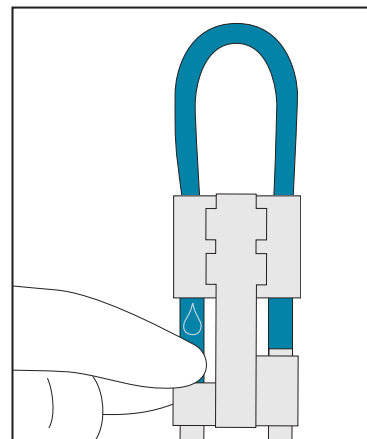

Figure 2-5 Pinch Tubing

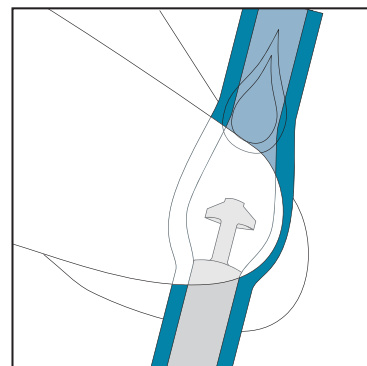

Figure 2-6 Tubing Segment Being Pinched

**Step 6:**

Press and hold **ON/OFF** key for 1.5 seconds to turn pump on. While pump runs through a self test, display will light and an audible alarm will sound as pump displays the nine digit serial number three digits at a time for one second each. The display will then show the letter 'R' followed by a number, which is the software revision.

Next, all segments of display will be shown for 2 seconds. **Verify all display segments and symbols are active.**

The self test is complete and pump will then display last programmed rate and will be in pause mode.

If any air is still in the tubing, continue to Step 7 to use pump prime feature.

**Step 7:**

Press and hold **PRIME** key. Alarm will sound once and pump will begin pumping at the maximum rate of 600 ml/hr. Display will read "TO STOP LET GO" (Figure 2-9). Once all air is removed from tubing, release key. Pump will stop, display will revert to last programmed rate, and pump will be in pause mode.

**For pump operation instructions:**

- ▶ For a Single Feeding Example: go to *Page 10*.
- ▶ For an Interval Feeding Example: go to *Page 13*.

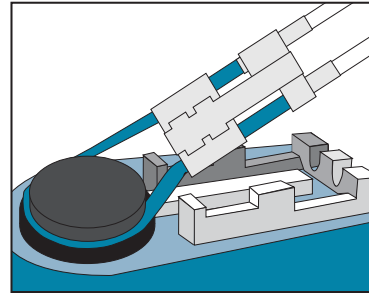

Figure 2-7 Seat Cassette

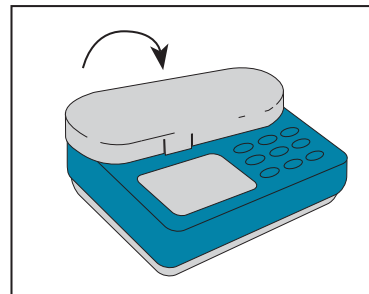

Figure 2-8 Close Pump Door

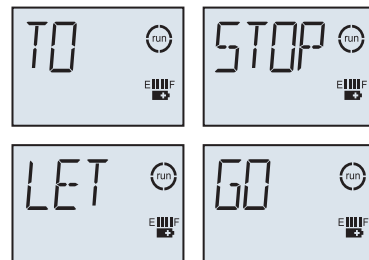

Figure 2-9 Priming Indication



## Operating the Pump A Single Feeding Example

If you want to deliver 500 ml of enteral feeding solution at a rate of 120 ml/hr and then stop the pump:

*Key Sequence for “A Single Feeding Example”*

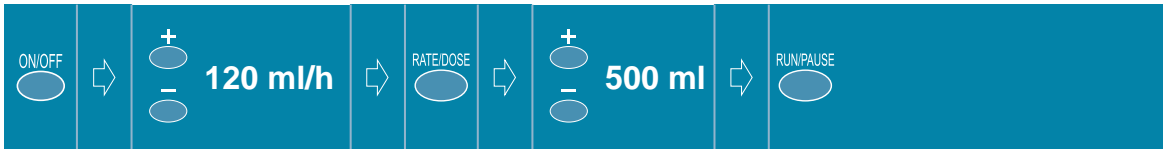

### Step 1:

Prepare the disposable set with enteral feeding solution as described in the Priming and Loading the Disposable Set instructions (page 7).

### Step 2:

Hang feeding bag or container so that the bottom of bag is at or above the level of the pump door.

**OR** - If an EnteraLite Infinity carry pack is to be used, load pump and feeding bag into the proper compartments, securing pump, bag and tubing with the pack's straps (Page 32).

### Step 3:

Turn pump on by pressing the **ON/OFF** key. After running the self test, display will show last programmed rate.



Figure 2-10 Program Rate to 120 ml/hr

### Step 4:

Press the **+** or **-** key to change the rate to 120 ml/hr. Hold down either key to change rapidly (Figure 2-10).

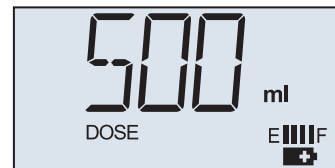
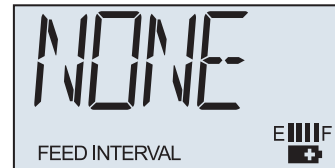

Figure 2-11 Program Dose to 500 ml

### Step 5:

Press the **RATE/DOSE** key to display dose. Press the **+** or **-** key until a dose of 500 ml is displayed (Figure 2-11).

NOTE: For a single feeding the feed interval setting should be programmed to NONE (*Figure 2-12*). When you have finished setting rate and dose check the display to see if it reads FEED INTERVAL. If it does, press the **FEED INT** key, then press the **CLEAR** key. Display will read NONE.



*Figure 2-12 Clear Feed Interval*

### Step 6

Connect barbed adapter to the patient's enteral feeding tube.

### Step 7

Press the **RUN/PAUSE** key. Pump will begin running. Display will show programmed rate and the arcs around the run symbol will rotate (*Figure 2-13*).

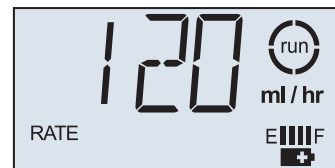

*Figure 2-13 Pump is Running*

While pump is running, the following may be viewed by pressing the appropriate key: Rate, Dose, and Feed Interval.

To view the amount delivered in the current feeding, press the **VOL/TOTAL** key (*Figure 2-14*). This counter will reset itself when the previously programmed dose has been completed and a new feeding is started, or if a feeding is interrupted and Rate, Dose or Feed Interval is changed.



*Figure 2-14 Amount Currently Delivered*

To view the amount delivered over the course of several feedings press the **VOL/TOTAL** key a second time. Display will read TOTL then the amount. This counter never resets itself. It can only be reset by the user (*Figure 2-15*).



*Figure 2-15 Total Amount Delivered*

While pump is running, the settings cannot be changed and the Prime feature is disabled.

If you want to stop pump at any time, press the **RUN/PAUSE** key. Display will show rate, and pump will be in pause mode. Or, turn pump off by pressing the **ON/OFF** key.

When you would like to restart pump, press the **ON/OFF** and/or the **RUN/PAUSE** key. Pump will save the memory of where it was in the feeding before stopping. Press the **RUN/PAUSE** key and pump will restart at the point where it was stopped.

NOTE: Any changes to pump settings during a feeding cycle will cause pump to start a new feeding; it will not start where it left off.

### Feeding Completion:

When the dose has been completely delivered, pump will stop running, and display will read DOSE DONE. Pump will be in a pause mode until it is turned off or feeding is restarted. To clear DOSE DONE, press and hold the **ON/OFF** key for 1.5 seconds to turn pump off, or press the **RUN/PAUSE** key to put pump in pause mode. Adjustments to settings can be made at this time, or press the **RUN/PAUSE** key a second time to start another feeding using same rate, dose, and feed interval settings.

If you would prefer the alarm to sound when the dose is complete, you can change the pump dose complete alarm setting to BEEP WHEN DONE. See the User Preference Settings section (*Page 19*) for instructions to change this setting. When set to BEEP WHEN DONE, the pump will stop at the end of the feeding, beep intermittently, and display will read DOSE DONE (*Figure 2-16*). To silence alarm when the dose is complete, press and hold the **ON/OFF** key for 1.5 seconds to turn pump off, or press the **RUN/PAUSE** key to put pump in pause mode.



Figure 2-16 DOSE DONE

NOTE: To program an infinite dose, press and hold the **+** key until display reads INF. When an infinite dose has been programmed, pump will not alarm DOSE DONE. Pump will run continuously as long as feeding solution remains in the bag. When empty, pump will alarm NO FOOD or NO FLOW IN.

**Next Feeding:**

Turn pump on. Previous settings for rate, dose, and feed interval will be saved in memory. If no changes are required, verify each setting is correct and restart pump running.

NOTE: Rate, dose, and feed interval settings can be locked so that changes cannot be made. See the User Preference Settings section (*Page 19*) for instructions to change this feature.

### Operating the Pump

#### An Interval Feeding Example

If you want to deliver 100 ml of enteral feeding solution at a rate of 50 ml/hr, and repeat this feeding every 6 hours:

*Key Sequence for “An Interval Feeding Example”*

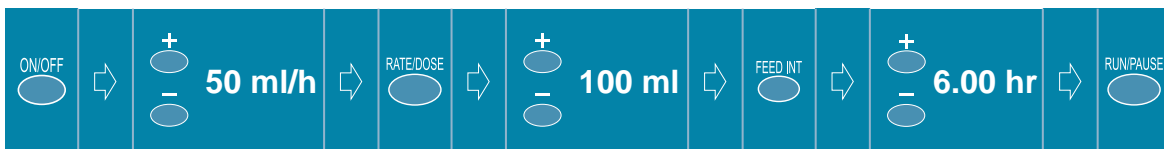
**Step 1:**

Prepare the disposable set with enteral feeding solution as described in the Priming and Loading the Disposable Set instructions (*Page 7*).

**Step 2:**

Hang feeding bag or container so that the bottom of bag is at or above the level of the pump door.

**OR** - If an EnteraLite Infinity pack is to be used, load the pump and feeding bag into the proper compartments, securing pump, bag and tubing with the pack's straps (see *Page 32*).

**Step 3:**

Turn pump on by pressing the **ON/OFF** key. After running the self test, display will show last programmed rate.

**Step 4:**

Press the **+** or **-** key to change the rate to 50 ml/hr. Hold down either key to change rapidly (*Figure 2-17*).



*Figure 2-17 Program Rate to 50 ml/hr*

**Step 5:**

Press the **RATE/DOSE** key to display dose. Press the **+** or **-** key until a dose of 100 ml is displayed (*Figure 2-18*).

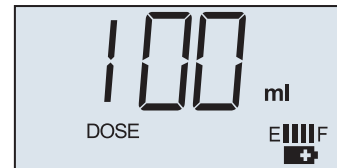

*Figure 2-18 Program Dose to 100 ml*

**Step 6:**

Press the **FEED INT** key to display the feed interval setting. Press the **+** or **-** key until 6.00 hr is displayed (*Figure 2-19*).



*Figure 2-19 Program Feed Interval 6.00 hr*

**NOTE:** The amount of time to complete a rate and dose combination can be figured by dividing the dose by the rate (Dose/Rate = Time). The number of hours to be programmed as the feed interval is the amount of time to deliver the dose plus the amount of time pump should pause. Example: 100 ml divided by 50 ml/hr equals 2 hours for feeding delivery, plus a pause of 4 hours equals a feeding interval of 6 hours (100 ml ÷ 50ml/hr = 2 hours running + 4 hours pause = 6 hours from feeding start time to start time).

Pump will calculate number of hours it will take to deliver the rate and dose combination. When the **FEED INT** key is pressed the first available value will be compatible with that combination. In this example the first available value will be 2.00 hr.

**NOTE:** Feed interval is displayed in hours and minutes, i.e. 5.10 = 5 hours and 10 minutes.

**NOTE:** Feed interval cannot be programmed if rate and dose combination requires more than 24 hours to deliver.

**Step 7:**

Connect barbed adapter to patient's enteral feeding tube.

**Step 8:**

Press the **RUN/PAUSE** key. Pump will begin running. Display will show programmed rate, the arcs around the run symbol will rotate and display will read FEED INTERVAL (*Figure 2-20*).



*Figure 2-20  
Pump is Running*

While pump is running the following may be viewed by pressing the appropriate key: Rate, Dose, and Feed Interval.

To view the amount delivered in the current feeding, press the **VOL/TOTAL** key (*Figure 2-21*). This counter will reset itself when the previously programmed dose has been completed and a new feeding is started, or if a feeding is interrupted and Rate, Dose or Feed Interval is changed.



*Figure 2-21 Amount  
Currently Delivered*

To view the amount delivered over the course of several feedings press the **VOL/TOTAL** key a second time (*Figure 2-22*). Display will read TOTL then the amount. This counter never resets itself, it can only be reset by the user.



*Figure 2-22  
Total Amount Delivered*

While pump is running, the settings cannot be changed and the Prime feature is disabled.

If you want to stop pump at any time, press the **RUN/PAUSE** key. Display will show rate, and pump will be in pause mode. Or, turn pump off by pressing the **ON/OFF** key.

When you would like to restart pump, press the **ON/OFF** and/or the **RUN/PAUSE** key. Pump will save the memory of where it was in the feeding before stopping. Press the **RUN/PAUSE** key and pump will restart at the point where it was stopped.

**NOTE:** Any changes to pump settings during a feeding cycle will cause pump to start a new feeding; it will not start where it left off.

**Feeding Completion:**

When the dose has been completely delivered, pump will stop running and display will read NEXT DOSE then give the number of hours and minutes until feeding will be repeated (Figure 2-23). Display will show the run symbol flashing without the arcs rotating around it. Pump will repeat this cycle until disposable set is empty or until it is stopped by user.

NOTE: When a feed interval has been programmed, pump will not alarm DOSE DONE. Pump will cycle continuously as long as feeding solution remains in the bag. When empty, pump will alarm NO FOOD or NO FLOW IN.

To stop feeding, press the **ON/OFF** key for 1.5 seconds to turn pump off or press the **RUN/PAUSE** key to put pump in pause mode. Adjustments to settings can be made at this time.

**New Feeding Cycle:**

Turn pump on. Previous settings for rate, dose, and feed interval will be saved in memory. If no changes are required, verify each setting is correct and restart pump running.

NOTE: Rate, dose, and feed interval settings can be locked into place so that changes cannot be made. See the User Preference Settings section (Page 19) for instructions to change this feature.

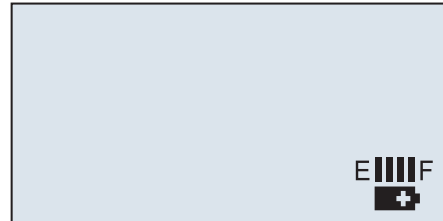

Figure 2-23  
Time Until Next Feeding

## The Battery Running on Battery Power

EnteraLite Infinity will run for 24 hours at a rate of 125 ml/hr. A fully depleted battery takes approximately 6 hours to fully charge.

When pump is running on battery power the battery symbol will appear in the display (*Figure 2-24*).



*Figure 2-24 Battery Power Indicator*

The segments or blocks between E and F represent the fuel gauge of the battery. Each block represents approximately 6 hours of charge. When each bar is half spent, it will begin to flash, indicating approximately 3 hours of charge is left for that bar. When the last block is gone, the battery symbol will blink to indicate there is approximately 1 hour of charge left. Display will flash LOW BATT every 3 seconds and pump will beep every 2 seconds to remind user of low battery condition. When battery is fully depleted pump will turn off automatically.

NOTE: The battery life is an approximation based on a fully charged battery and a flow rate of 125 ml/hr. Higher flow rates will run the battery down faster, while lower flow rates and interval feedings will allow the battery to last longer. Battery life degrades over time.



### The Battery Charging the Battery

To charge the battery, insert plug from AC Adapter/Charger into port on the left side of pump. Plug charger into a wall outlet.

Pump will charge whether it is turned off or running.

When charger is plugged in and charging, the plug symbol will appear in the display and the fuel gauge will display four bars scrolling from E to F. This pattern continuously repeats while pump is charging (Figures 2-25a through 2-25e). When bars stop scrolling pump is done charging.

To check the status of battery during charging, disconnect charger from pump and turn on pump.

NOTE: If pump shut down due to low battery, charging less than 10 minutes may result in an ER99 alarm. Fully charge battery if depleted (see page 22 to clear alarm).

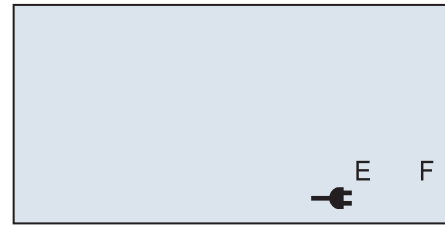

a

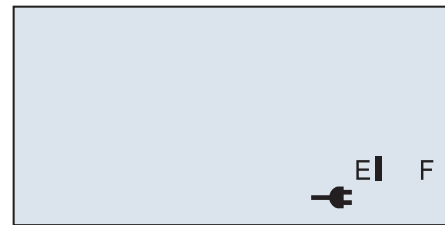

b

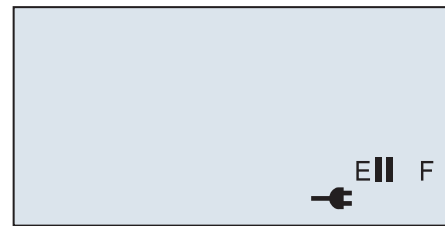

c

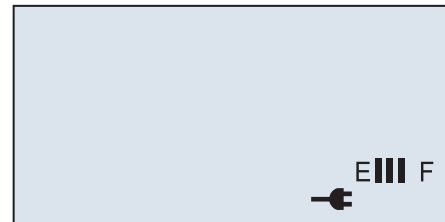

d



e

Figure 2-25 Fuel Gauge

### User Preference Settings

There are four user preference settings. These settings can be changed to fit the user's needs.

#### Alarm Volume:

The alarm has two volumes, high or low. Pump default is low (*Figure 2-26*).

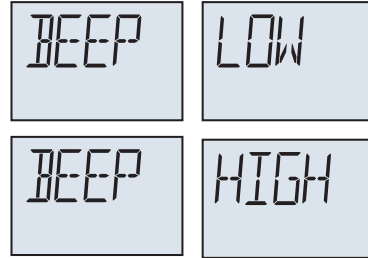

*Figure 2-26 Alarm Volume Settings BEEP LOW and BEEP HIGH*

#### Settings Lock:

This allows user to set a rate, dose, and feed interval and then lock those settings so they cannot be changed unintentionally. This will also lock the volume counters from being unintentionally cleared. Pump default is unlocked (*Figure 2-27*).

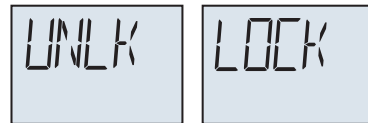

*Figure 2-27 Settings Lock UNLK and LOCK*

#### Dose Done:

There are two settings for the DOSE DONE alarm: MUTE WHEN DONE or BEEP WHEN DONE. Pump default is MUTE WHEN DONE (*Figure 2-28*).



*Figure 2-28 Dose Done Settings BEEP WHEN DONE and MUTE WHEN DONE*

#### Backlight:

To conserve battery life, the backlight will turn off automatically 10 seconds after the last key has been pressed. However, while pump is connected to an A/C current the backlight settings can be adjusted. The light can be set to ON or OFF. With the ON setting the backlight will remain on the entire time pump is plugged in to a live power outlet. With the OFF setting, the backlight will turn on when a key is pressed and turn off 10 seconds after the last key has been pressed. Pump default is ON (*Figure 2-29*).

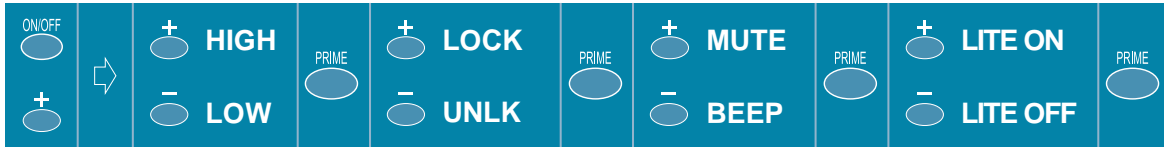

*Figure 2-29 Backlight Settings LITE OFF and LITE ON*

NOTE: Regardless of setting, the backlight will always turn off 10 seconds after pump is turned off.

### To adjust these settings:

Key Sequence for “Adjusting User Preference Settings”



#### Step 1:

With pump turned off, press and hold for 1.5 seconds the **+** and the **ON/OFF** keys at the **same time**. Pump will beep and then display the words BEEP HIGH or BEEP LOW.

Press the **+** key to change to HIGH or the **-** key to change to LOW. Pump will give a triple beep when the **+** or **-** keys are pressed and setting will change. If setting is as desired, do not press either key.

#### Step 2:

Press the **PRIME** key. Display will read UNLK (unlocked) or LOCK (locked).

Press the **+** key to change to LOCK (locked) or the **-** key to change to UNLK (unlocked). If setting is as desired, do not press either key.

#### Step 3:

Press the **PRIME** key again. Display will read MUTE WHEN DONE or BEEP WHEN DONE.

Press the **+** key to change to BEEP WHEN DONE or the **-** key to change to MUTE WHEN DONE. If setting is as desired, do not press either key.

#### Step 4:

Press the **PRIME** key again. Display will read LITE ON or LITE OFF.

Press the **+** key to change to LITE ON or the **-** key to change to LITE OFF. If setting is as desired, do not press either key.

#### Step 5:

Press the **ON/OFF** to turn pump off. Setting changes will be saved automatically.

## 3. ALARMS, MESSAGES, AND INDICATIONS

Following is a list of all alarms, display messages, and indications that are used by the EnteraLite Infinity enteral feeding pump. Each alarm, message, or indication is described in detail on the following pages:

Figure	Description	Page
<b>Alarms</b>		
3-1	ER01 - ER99 (or ERRA - ERRZ) .....	22
3-2	LOAD SET .....	22
3-3	LOW BATT .....	22
3-4	NO FLOW IN .....	23
3-5	NO FLOW OUT .....	23
3-6	NO FOOD .....	24
3-7	PUSH RUN TO FEED .....	24
3-8	SHUT DOOR .....	25
<b>Messages</b>		
3-9	DOSE DONE .....	25
3-10	NEXT DOSE .....	25
<b>Indications</b>		
3-11	CHEK .....	26
3-12	TO STOP LET GO .....	26
	Battery Doesn't Hold Its Charge .....	27
	Battery Doesn't Charge .....	27
	Charger Installed but No Plug Symbol Visible .....	27

Should any of these alarms or indications continue after troubleshooting, contact your healthcare provider for pump service.

## Alarms

### ER01 - ER99 or ERRA - ERRZ (Figure 3-1)

Pump will sound a continuous beep and display will read ER followed by a two digit number or ERR followed by a letter to indicate a self-test has failed.

**To clear alarm:** Turn the pump off and then back on.

**WARNING:** If an error occurs (ER01 - ER99 or ERRA - ERRZ will appear in display), all settings and volume counters should be checked and verified before starting a feeding.



Figure 3-1 ER01 - ER99 or ERRA - ERRZ Alarm

### LOAD SET (Figure 3-2)

Pump will sound a dual tone beep repeatedly and display will read LOAD SET.

**Why:** This alarm will sound when pump attempted to run with the set improperly loaded or missing.

**To correct the problem:** Press the **RUN/PAUSE** key to silence alarm and place pump in pause mode, then check the following:

1. An EnteraLite Infinity disposable set is loaded into pump properly and door is closed.
2. Check cassette receptacle for cleanliness, especially around pressure sensors. If cleaning is necessary, refer to *CHAPTER 5 - CLEANING* (Page 31).



Figure 3-2 LOAD SET Alarm

### LOW BATT (Figure 3-3)

When 1 hour or less of battery life is available, display will flash LOW BATT every 3 seconds and pump will beep every 2 seconds to indicate battery is low and pump will soon stop running.

**To correct the problem:** Plug in AC Adapter/Charger to recharge battery.



Figure 3-3 LOW BATT Alarm

**NO FLOW IN** (Figure 3-4)

Pump will sound a dual tone beep repeatedly and display will read NO FLOW IN.

**Why:** This alarm has occurred because pump has detected blockage in the set between pump and bag.

**To correct the problem:** Press the **RUN/PAUSE** key to silence alarm and place pump in pause mode, then check the following:

1. Check tubing for kinks or formula clumps. Correct blockage.
2. Check cassette receptacle for cleanliness, especially around the pressure sensors. If cleaning is necessary, refer to *CHAPTER 5 - CLEANING* (Page 31).



Figure 3-4  
NO FLOW IN Alarm

**NO FLOW OUT** (Figure 3-5)

Pump will sound a dual tone beep repeatedly and display will read NO FLOW OUT.

**Why:** This alarm has occurred because pump has detected a blockage in the set between pump and patient.

**To correct the problem:** Press the **RUN/PAUSE** key to silence alarm and place pump in pause mode, then check the following:

1. Check tubing for kinks or blockages. Remove kink or blockage.
2. Check cassette receptacle for cleanliness, especially around pressure sensors. If cleaning is necessary, refer to *CHAPTER 5 - CLEANING* (Page 31).
3. Back pressure from patient may also cause this alarm. Discuss with physician.



Figure 3-5  
NO FLOW OUT Alarm

### NO FOOD (Figure 3-6)

Pump will sound a dual tone beep repeatedly and display will read NO FOOD.

**Why:** This alarm has occurred because pump has detected air in the tubing. It takes approximately 1 ml of air, which is approximately 5 inches (12.7 cm) in length entering the teal colored tubing to cause an alarm.

**To correct the problem:** Press the **RUN/PAUSE** key to silence alarm and place pump in pause mode, then check the following:

1. Check feeding bag for food. If it is empty, refill bag and prime the set to remove air from the bag and tubing.
2. Check tubing for air bubbles. If bag is full but air is present in the tubing, disconnect set from patient, press and hold the **PRIME** key until air bubble has moved to the end of the tubing.
3. Check cassette receptacle for cleanliness, especially around the air sensor. If cleaning is necessary, refer to *CHAPTER 5 - CLEANING (Page 31)*.
4. Check that an EnteraLite Infinity disposable set is loaded into pump properly and door is closed.
5. Check disposable set for worn tubing. If it is worn, replace with a new set.

**NOTE:** Blenderized or aggressively mixed solutions may have foam. Small foam bubbles may collect in the air sensor area and must be cleared in order to avoid a NO FOOD alarm. Allowing foamy solutions to sit for 10 to 15 minutes after mixing and prior to pouring into the bag will reduce the amount of foam.

### PUSH RUN TO FEED (Figure 3-7)

Pump will sound a dual tone beep repeatedly and display will read PUSH RUN TO FEED.



Figure 3-6  
NO FOOD Alarm



Figure 3-7 PUSH RUN TO  
FEED Alarm

**Why:** This alarm has occurred because pump has been in pause mode for 2 minutes.

**To correct the problem:** Press the **RUN/PAUSE** key to silence alarm and place pump in pause mode again. Program and use pump or press the **ON/OFF** key to turn it off.

### SHUT DOOR (Figure 3-8)

Pump will sound a dual tone beep repeatedly and display will read SHUT DOOR. Note: This alarm is available only on select pumps.

**Why:** This alarm has occurred because the pump door was opened while pump was running.

**To correct the problem:** Press the **RUN/PAUSE** key to silence alarm and place pump in pause mode then shut the door. Check door is latched securely. If door will not stay closed, check door latch and latch pocket on pump are not broken or cracked.

## Messages

### DOSE DONE (Figure 3-8)

This message indicates a single feeding dose has been delivered.

**To clear pump:** Either press the **ON/OFF** key to turn pump off, or press the **RUN/PAUSE** key to put pump in pause mode before starting another feeding.

### NEXT DOSE (Figure 3-9)

If the interval feeding feature is in use, between feedings display will read NEXT DOSE ##.## hr. (##.##, indicates the time in hours and minutes until the next dose begins.)

If the currently programmed feeding is not desired, either press the **ON/OFF** key to turn pump off or press the **RUN/PAUSE** key to place pump in pause mode where adjustments can be made to the settings.

 A digital display showing the word "SHUT" in a large, blocky, seven-segment font.

 A digital display showing the word "DOOR" in a large, blocky, seven-segment font.

Figure 3-8  
SHUT DOOR Alarm

 A digital display showing the word "DOSE" in a large, blocky, seven-segment font.



 A digital display showing the word "DONE" in a large, blocky, seven-segment font.

Figure 3-9  
DOSE DONE Message

 A digital display showing the word "NEXT" in a large, blocky, seven-segment font.

 A digital display showing the word "DOSE" in a large, blocky, seven-segment font.

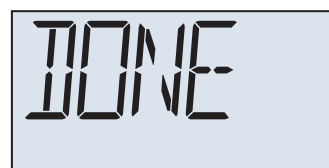
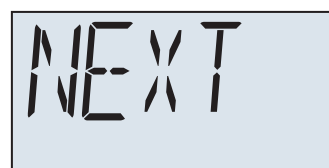
Figure 3-10  
NEXT DOSE Message



## Indications

### CHEK (Figure 3-11)

Pump will sound a dual tone beep once and CHEK, RATE, DOSE, and FEED INTERVAL will all blink on the display.

**Why:** This alarm sounds when the RATE, DOSE, and FEED INTERVAL are not compatible. As discussed in the Interval Feeding Example (Page 13), pump divides the dose by the rate to determine the amount of time required for the dose to be delivered. Based on the RATE and DOSE combination, when the FEED INTERVAL is being programmed, the first value available will be the first value that is compatible with the RATE and DOSE settings. Should the RATE or DOSE be changed after the FEED INTERVAL has been programmed, and the combination requires the delivery time to be longer than the amount of time programmed as the FEED INTERVAL, user will receive this alarm.

For example, if rate is 100 ml/hr, and dose is 200 ml, then the pump will take 2 hours to deliver the dose. The first available FEED INTERVAL will be 2.00 hr. However, if the dose is changed to 300 ml, the dose will now take 3 hours to deliver and therefore 2.00 hr is an impossible FEED INTERVAL. If the **RUN/PAUSE** key is pressed before the FEED INTERVAL has been changed (the next available value being 3.00), the pump will give the CHEK alarm.

**To correct the problem:** Press the RUN/PAUSE key to put pump in pause mode, and reprogram the settings.

### TO STOP LET GO (Figure 3-12)

When pressing and holding the **PRIME** key, alarm will sound once, pump will begin pumping at maximum rate of 600 ml/hr and display will read "TO STOP LET GO".

**To stop priming:** Release the **PRIME** key.

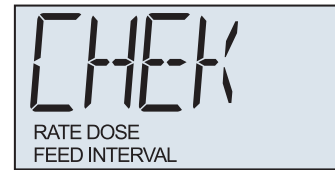

Figure 3-11  
CHEK Indication

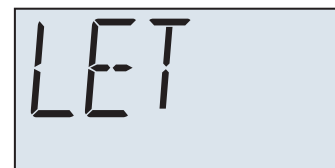

Figure 3-12  
Priming Indication

### Battery Doesn't Hold Its Charge

Battery will lose its charge if stored for a long period of time or if stored at high temperatures (such as in an automobile during summer).

**To correct the problem:** Recharge the battery. If the problem continues during regular use, contact your healthcare provider for service.

### Battery Doesn't Charge

If the battery symbol and the E and F of the fuel gauge (*Figure 3-13*) are flashing while the pump is plugged in, the battery is not charging.

**To correct the problem:** Contact your healthcare provider for service.



*Figure 3-13 Battery Symbol and the E and F of the Fuel Gauge*

### Charger Installed but No Plug Symbol Visible

If the plug symbol does not display after the AC Adapter/Charger is plugged into pump and a live power outlet, then charger is not charging battery.

**To correct the problem:** Check the following:

- ▶ Verify that the wall outlet works by plugging in another appliance, such as a lamp.
- ▶ Charger is connected properly.

If this does not correct the problem, pump or charger may be damaged. Contact your healthcare provider for service.

NOTE: There are no user serviceable or replaceable components inside the EnteraLite Infinity.

## 4. TROUBLESHOOTING GUIDE

### NO FOOD Alarm

If re-priming of the pump delivery set is required, it is advisable to disconnect the enteral adapter from the patient's feeding tube while re-priming.

<p>1. Is bag of pump delivery set empty?</p>	<p><b>YES</b></p>	<p>Refill bag, re-prime delivery set, and resume feeding</p>
<p><b>NO</b></p>		
<p>2. Is air present in the tubing?</p>	<p><b>YES</b></p>	<p>Has all air been removed from <b>bag</b> of pump delivery set?</p>
<p><b>NO</b></p>		
<p><b>NO</b></p>		<p><b>IF NO:</b> Manually prime tubing by turning bag upside down, gently squeezing lower half of bag while pinching the teal colored tubing just below the drop symbol. Hold this position until all air is removed from bag and tubing.</p>
		<p><b>IF YES:</b> Press and hold the PRIME key to move air in the tubing past pump delivery set cassette and resume feeding.</p>
<p>3. Is formula blenderized or aggressively mixed?</p>	<p><b>YES</b></p>	<p>Let formula sit for 10 - 15 minutes before preparing pump delivery set for feeding. If foam is present in tubing, flush by priming pump delivery set either manually or with the pump and resume feeding.</p>
<p><b>NO</b></p>		
<p>4. Are air bubbles trapped inside the cassette?</p>	<p><b>YES</b></p>	<p>Remove tubing from pump and manually prime tubing by turning bag upside down, gently squeezing lower half of bag while pinching the teal colored tubing just below the drop symbol. Hold this position until all air has passed through the teal segment of tubing.</p>
	<p><b>NO</b></p>	<p><b>If alarm continues, contact your healthcare provider or ZEVEX Customer Service at (800) 970-2337 for assistance.</b></p>

### ERRA, ERRD, ERRF, ER01, ER02, or ER03 Alarms

<p>1. Was pump door open while pump was turned on or while running?</p>	<p><b>YES / UNSURE</b></p>	<p>Turn pump off. Unload and reload delivery set cassette. Make sure door is closed securely, then turn pump back on.</p>
	<p><b>NO</b></p>	<p><b>If alarm continues, contact your healthcare provider or ZEVEX Customer Service at (800) 970-2337 for assistance.</b></p>

**LOAD SET Alarm**

1. Is door closed securely?	<b>NO / UNSURE</b>	Turn pump off. Unload and reload delivery set cassette. Make sure door is closed securely. Turn pump back on.
<b>NO</b>		
2. Is door cracked or tab on inside of door broken?	<b>YES</b>	Contact your healthcare provider or ZEVEX Customer Service at (800) 970-2337 to receive a new door.
	<b>NO</b>	Contact your healthcare provider or ZEVEX Customer Service at (800) 970-2337 for assistance.

**NO FLOW IN or NO FLOW OUT Alarms**

- ▶ **NO FLOW IN** - Occlusion between delivery set and pump.
- ▶ **NO FLOW OUT** - Occlusion between pump and patient.

1. Is delivery set tubing pinched, kinked, or clogged?	<b>YES</b>	Check delivery set for obstructions or kinks in tubing. Correct blockage and resume feeding.
<b>NO</b>		
2. Is tab on inside of door broken?	<b>YES</b>	Contact your healthcare provider or ZEVEX Customer Service at (800) 970-2337 to receive a new door.
<b>NO</b>		
3. Is pressure sensor region of cassette receptacle clean?	<b>NO</b>	Clean pressure sensor area with a cotton swab, soft cloth or dampened sponge, or wash entire pump under running water. Do not use abrasive materials or harsh chemicals.
<b>YES</b>		
4. Are there visible signs of damage to pressure sensors area?	<b>YES</b>	Contact your healthcare provider or ZEVEX Customer Service at (800) 970-2337 to return pump for service.
	<b>NO</b>	Disconnect from patient and fill a new delivery set with food. Prime set and start pump. <b>If alarm continues, contact your healthcare provider or ZEVEX Customer Service at (800) 970-2337 for assistance.</b>

### Charging Problems

<p>1. Is A/C adapter charger plugged into wall outlet and pump properly?</p>	<p><b>NO / UNSURE</b></p>	<p>Check connections for both wall plug and pump adapter. Green indicator light on charger wall plug should be illuminated and pump display should have plug symbol with scrolling bars between E and F of fuel gauge. When pump is fully charged, bars will stop scrolling.</p>
<p><b>YES</b></p>		
<p>2. Is wall outlet functioning properly?</p>	<p><b>NO / UNSURE</b></p>	<p>Plug another device into outlet to verify outlet is functioning properly.</p>
<p><b>YES</b></p>		
<p>3. Does the charger adapter appear to have any damage?</p>	<p><b>YES</b></p>	<p>Contact your healthcare provider or ZEVEX Customer Service at (800) 970-2337 to receive a new charger.</p>
<p><b>NO</b></p>		
<p>4. Does the charger port appear to have any damage including bent or missing pins?</p>	<p><b>YES</b></p>	<p>Contact your healthcare provider or ZEVEX Customer Service at (800) 970-2337 to return pump for service.</p>
<p><b>NO</b></p>		
<p>5. Is Battery Symbol and E and F of fuel gauge flashing?</p>	<p><b>YES</b></p>	<p>Contact your healthcare provider or ZEVEX Customer Service at (800) 970-2337 to return pump for service.</p>
	<p><b>NO</b></p>	<p>If condition continues, contact your healthcare provider or ZEVEX Customer Service at (800) 970-2337 to return pump for service.</p>

## 5. CLEANING

**WARNING:** To avoid electrical shock, never clean pump or EnteraLite Infinity AC Adapter/Charger with charger plugged into an outlet or pump turned on.

**WARNING:** Make sure the EnteraLite Infinity AC Adapter/Charger is completely dry before plugging into an electrical outlet.

### To clean the EnteraLite Infinity enteral feeding pump:

Pump may be cleaned with warm soapy water (standard dish soap) and a non-abrasive sponge or soft cloth. Use a cotton swab to clean pathways of cassette receptacle and to remove teal silicon residue from pump wheel roller pins.

**OR** - Apply one of the following solutions for approximately 10 minutes, then wipe pump clean with a damp cloth or sponge:

- ▶ 5% bleach and water solution
- ▶ Multipurpose household disinfectant cleaner

Rinse pump by holding under a stream of warm water. Then, dry with a clean cloth.

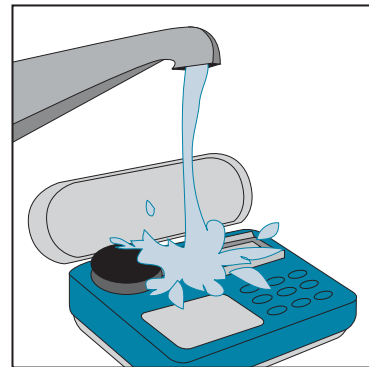

Figure 5-1 Rinsing Pump Under Stream of Water

**NOTE:** Avoid harsh cleaners/disinfectants. They may cause damage to pump surfaces and may affect pump functionality. ZEVEX has tested the following disinfectants for acceptability for cleaning/disinfecting the EnteraLite Infinity pump. These cleaning products are categorized below:

Acceptable	Unacceptable
Metrex CavaCide	Ball Ruthless
MetriCide 28	Wex-Cide 128
Vesphene Ilse	Alcohol
5% Bleach and Water Solution	
Warm Soapy Water (Standard Dish Soap)	

### To clean the Carrying Packs:

The EnteraLite Infinity packs are machine-washable. Use cold water and gentle cycle, whenever possible. Hang to dry.

### To clean the AC Adapter/Charger:

EnteraLite Infinity AC Adapter/Charger normally does not require cleaning. When desired, a dry or slightly damp cloth may be used to clean the outside surface of AC Adapter/Charger while it is disconnected from the wall outlet.

## 6. ACCESSORIES

### EnteraLite Infinity AC Adapter/Charger

Order Number INFCH01

Plug AC Adapter/Charger into a wall outlet and plug connector into pump to operate on AC power and/or recharge battery (*figure 6-1*).

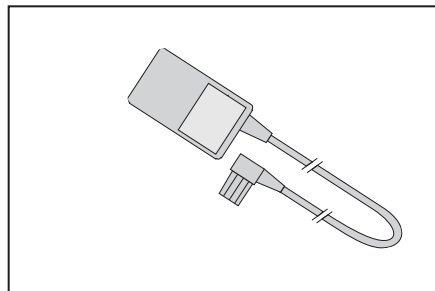

Figure 6-1 AC Adapter/Charger

### EnteraLite Infinity Pole Clamp

Order Number Z-11981

Thread bolt into receptacle on the back of pump and tighten gray wheel to mount pump on clamp. If gray wheel is slightly loosened, pump can be rotated to snap into different positions. Retighten gray wheel when pump is in the desired position. Tighten black wheel to mount clamp on a pole (*figure 6-3*).

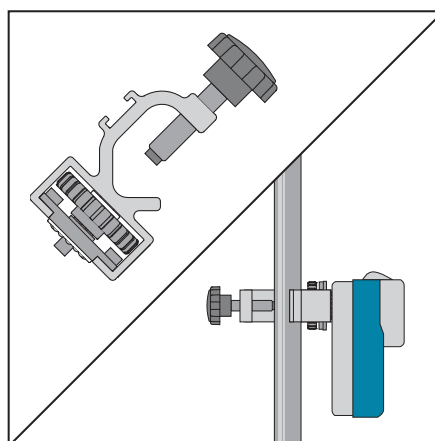

Figure 6-2 Pole Clamp / Pole Clamp with Pump Attached to IV Pole

### EnteraLite Infinity Adjustable Angle Pole Clamp

Order Number 26772-001

Thread bolt into receptacle on the back of pump and tighten knob to mount pump on clamp. If knob is slightly loosened, pump can be rotated to snap into different positions. Retighten knob when pump is in the desired position. Tighten black wheel to mount clamp on a pole. Pull pin to adjust angle (*figure 6-3*).

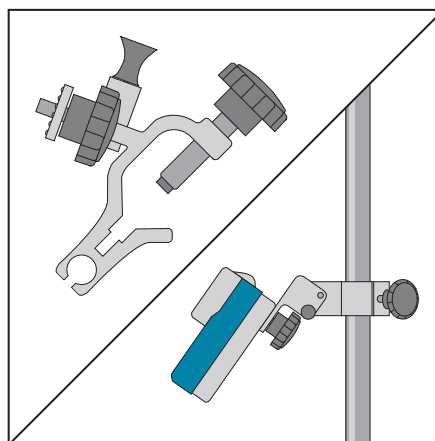

Figure 6-3 Adjustable Angle Pole Clamp / Adjustable Angle Pole Clamp with Pump Attached to IV Pole

### EnteraLite Infinity Mini Backpack

Order Numbers PCK1001 (red), PCK1002 (light green and gray), PCK1003 (black and gray), PCK1004 (specialty pack: call for current colors)

Pack holds EnteraLite Infinity with a 500 ml bag in the front section or can accommodate a 1200 ml bag in the rear section. Pump is secured with a Velcro® strap. A Velcro strap secures the neck of the 500 ml or 1200 ml bag. The tubing is loaded into pump and any excess length of tubing can be secured with a Velcro tab. The downstream tubing then feeds through a port at bottom of pack (either side). Also included in this pack is a pocket that may be used to hold an ice pack. *Dimensions: 13" H x 8" W x 4.5" D. Approximate weight when loaded with pump and 500ml delivery set filled with 500ml of water: 2.9 lbs.; 1200ml delivery set filled with 1200ml of water: 4.5 lbs.*



Figure 6-4 Mini Backpack

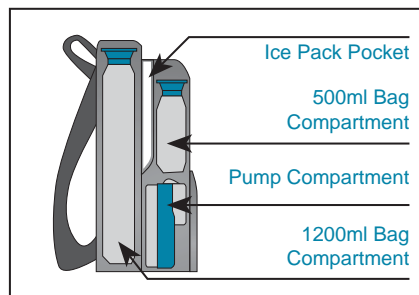

Figure 6-5 Mini Backpack (Cutaway View of Internal Compartments)

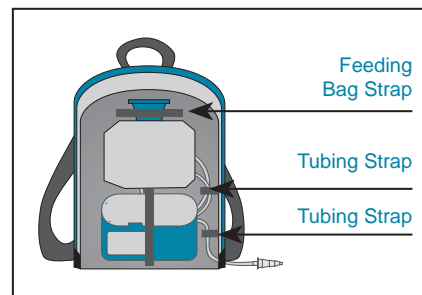

Figure 6-6 Mini Backpack (Cutaway View of Internal Straps)

### EnteraLite Infinity Super-Mini Backpack

Order Numbers PCK2001 (black), PCK2002 (light green and gray), PCK2003 (Specialty Pack: call for current colors)

Pack holds EnteraLite Infinity with a 500 ml bag. Pump is secured with a Velcro strap. A Velcro strap secures the neck of the 500 ml bag. The tubing is loaded into pump and any excess length of tubing can be secured with a Velcro tab. The downstream tubing then feeds through a port at bottom of pack (either side). *Dimensions: 9.5" H x 8" W x 4" D. Approximate weight when loaded with pump and 500ml delivery set filled with 500ml of water: 2.3 lbs.*



Figure 6-7 Super-Mini Backpack

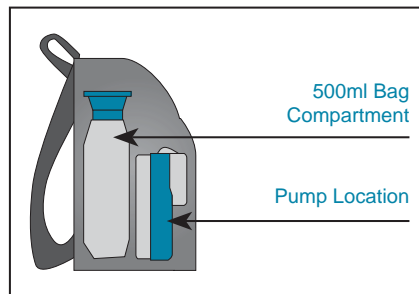

Figure 6-8 Super-Mini Backpack (Cutaway View of Internal Compartments)

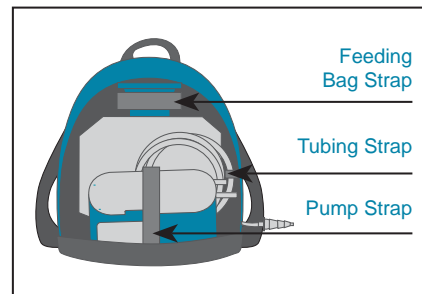

Figure 6-9 Super-Mini Backpack (Cutaway View of Internal Straps)



### EnteraLite Infinity Waist Pack

Order Numbers PCK3001 (black and gray)

Pack holds EnteraLite Infinity with a 500 ml bag. Pump is secured with an elastic strap. A Velcro strap secures the neck of the 500 ml bag. The tubing is loaded into pump and any excess length of tubing can be secured with a Velcro tab. The downstream tubing then feeds through a port at bottom of pack (either side).

Dimensions: 7" H x 11" W x 3" D

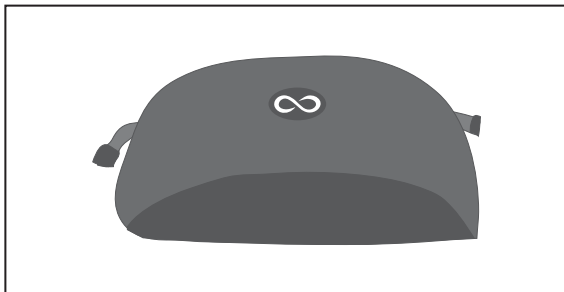

Figure 6-10 Waist Pack

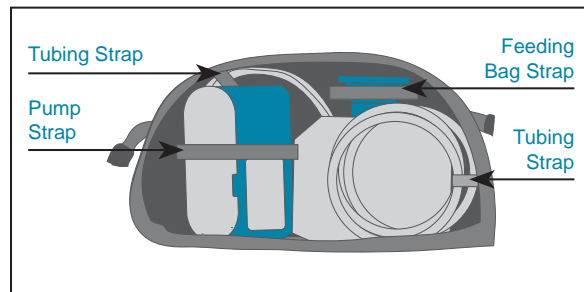

Figure 6-11 Waist Pack (Cutaway View of Internal Compartment and Straps)

### EnteraLite Infinity Backpack

Order Numbers PCK4001 (black and gray)

Pack holds EnteraLite Infinity with a 500 ml bag or a 1200 ml bag. Pump is secured with a Velcro® strap. A Velcro strap secures the neck of the 500 ml or 1200 ml bag. The tubing is loaded into pump and any excess length of tubing can be secured with a Velcro tab. The downstream tubing then feeds through a port at bottom of pack (either side). Also included in this pack is a pocket that may be used to hold an ice pack. Dimensions: 17" H x 8" W x 4" D.



Figure 6-12 Backpack

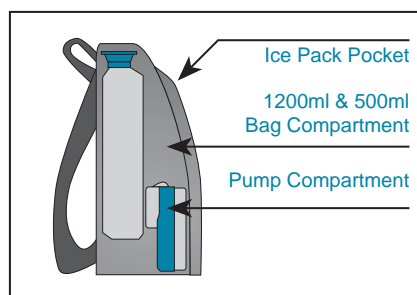

Figure 6-13 Backpack (Cutaway View of Internal Compartments)

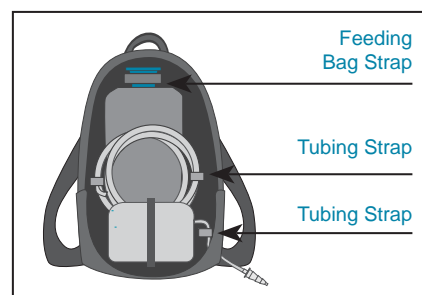

Figure 6-14 Backpack (Cutaway View of Internal Straps)

## 7. SPECIFICATIONS

<b>SIZE</b>	Pump Dimensions: Pump Weight:	1.95" H x 5.65" W x 4.05" D 14.4 oz (411.0 g)
<b>BATTERY</b>	Type: Life: Charge Time: Charge Level Indicator Compact Wall Charger	Lithium Ion 24 hours @ 125 ml/hr approximately 6 hours
<b>DISPLAY</b>	Backlit LCD	
<b>OPERATING ORIENTATION</b>	Any	
<b>FLOW RATE</b>	Range: Increment:  Accuracy:	0.1 - 600 ml/hr 0.1 ml/hr from 0.1 ml/hr to 10 ml/hr 1 ml/hr from 10 ml/hr to 600 ml/hr $\pm 5\%$ (see page 37)
<b>DOSE</b>	Range: Increment:	0.1 ml to 3000 ml or infinite dose 0.1 ml from 0.1 - 10 ml 1 ml from 10 - 1000 ml 10 ml from 1000 - 3000 ml
<b>VOLUME DISPLAY</b>	Current Dose Status Accumulated	
<b>INTERVAL FEED</b>	Interval Feed Indication Displays Time to Next Feed	
<b>PROGRAM MEMORY RETAINED</b>	When Pump is on or off	
<b>PEDIATRIC USE</b>	Yes	
<b>PRIME</b>	Yes	
<b>DISPOSABLE SET FEATURES</b>	Automatic Free-flow Protection No Drip Chamber DEHP-free	

## 7. SPECIFICATIONS

---

<b>ALARMS</b>	CHEK	Programming error - Incompatible RATE, DOSE, and FEED INTERVAL settings
	ER01 - ER99 or ERRA - ERRZ	Self-test error
	LOAD SET	Set not loaded properly
	LOW BATT	Battery Low
	NO FLOW IN	Upstream occlusion -5 psi (-34 kPa) Tolerance = $\pm$ 3psi (21 kPa) psi (pounds per square inch) kPa (kilopascals)
	NO FLOW OUT	Downstream occlusion, 12 psi (83 kPa) Tolerance = $\pm$ 3psi (21 kPa) psi (pounds per square inch) kPa (kilopascals)
	NO FOOD	Air in tubing - bag or set may be empty
	PUSH RUN TO FEED	Pump unused for 2 minutes
	SHUT DOOR	Door opened while pump was running

---

<b>ACCESSORIES</b>	AC Adapter/Charger Multi-position Pole Clamp (rotates 360°) Multi-purpose EnteraLite Infinity Custom Carry Packs
--------------------	--

---

<b>WARRANTY</b>	2 years
-----------------	---------

---

<b>OPERATING ENVIRONMENT</b>	Temperature:	41 °F to 104 °F (5 °C to 40 °C)
	Humidity:	30% to 95% noncondensing

---

<b>STORAGE ENVIRONMENT</b>	Temperature:	-4 °F to 149 °F (-20 °C to 65 °C)
	Humidity:	10% to 95% noncondensing

---

<b>CLASSIFICATION INFORMATION</b>	EnteraLite Infinity Enteral Feeding Pump with internal battery – Type BF Applied Part
-----------------------------------	---

EnteraLite Infinity AC Adapter / Charger – Class II

## 8. IMPORTANT PEDIATRIC CONSIDERATIONS

EnteraLite Infinity can be used on pediatric patients if the specifications of pump meet delivery requirements of the patient. The specifications of primary importance are:

- ▶ The flow rate range of EnteraLite Infinity is 0.1 ml/hr to 10 ml/hr in 0.1 ml/hr increments and 10 ml/hr to 600 ml/hr in 1 ml/hr increments.
- ▶ The EnteraLite Infinity pump delivers the dose at the specified rate within +/- 5% volumetric flow rate accuracy under the following conditions:
  - ▶▶ utilizing ZEVEX EnteraLite Infinity disposable sets
  - ▶▶ fluid head height at +6.0 inches  $\pm$  0.3 inches (+15.24 cm  $\pm$  0.76 cm) with respect to center of rotor.

Note: Head height affect on accuracy is shown below (*figure 8-1*).

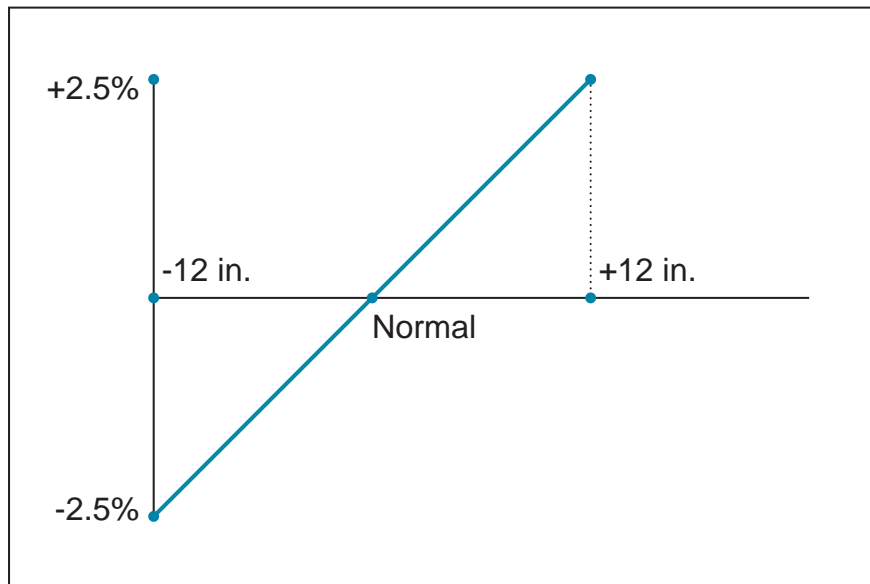

*Figure 8-1 Head Height Affect on Accuracy*

If these specifications meet the required feed regimen, EnteraLite Infinity can be used to deliver enteral formulas to pediatric patients. ALWAYS VERIFY RATE, DOSE AND FEED INTERVAL BEFORE PROCEEDING TO FEED.

## 9. ADDITIONAL TECHNICAL INFORMATION

### Electromagnetic Emissions/Interference

Electromagnetic emissions may affect the operation of any electronic medical device, including enteral feeding pumps.

The EnteraLite Infinity will not be affected by electromagnetic emissions in most environments. However, some electromagnetic fields produced by personal communication equipment, household appliances, or occupational tools may cause electromagnetic interference (EMI) which can affect the pump.

Possible sources of electromagnetic interference with electronic medical devices include, but are not limited to: cellular phones, cordless telephones, microwave ovens, anti-theft/security systems, blenders, and high-powered tools (i.e. drills, saws, chain saws). If electromagnetic emitting devices are operated within one yard/ meter of the EnteraLite Infinity, the pump may automatically shut off and settings may return to their default values. Check the pump regularly if operating near sources of electromagnetic emissions.

The EnteraLite Infinity can safely be operated on commercial aircraft and is designed in accordance with EN 60601-1-2, EN 60601-1-4 and RTCA DO160D standards for electromagnetic emissions and immunity.

<b>Guidance and manufacturer's declaration - electromagnetic emissions</b>		
The EnteraLite Infinity is intended for use in the electromagnetic environment specified below. The customer or the user of the EnteraLite Infinity should assure that it is used in such an environment.		
<b>Emissions Test</b>	<b>Compliance</b>	<b>Electromagnetic environment - guidance</b>
RF emissions CISPR 11	Group 1	The EnteraLite Infinity uses energy only for its internal function. Therefore, its RF emissions are very low and are not likely to cause any interference in nearby electronic equipment.
RF emissions CISPR 11	Class B	
Harmonic emissions IEC 61000-3-2	Class A	The EnteraLite Infinity is suitable for use in all establishments, including domestic establishments and those directly connected to the public low-voltage power supply network that supplies buildings used for domestic purposes.
Voltage fluctuations/flicker emissions IEC 61000-3-3	Complies	

### **EnteraLite Infinity Disposable Set Displacement**

EnteraLite Infinity Disposable Set displaces approximately 15ml of fluid when primed. Approximately 3.5 ml of air is drawn into the tubing before the enteral pump detects bag is empty. Therefore, approximately 11.5 ml of fluid remains in the disposable set when pump stops feeding.

### **Routine Maintenance**

There are no user serviceable parts or routine calibration or adjustment procedures required for EnteraLite Infinity. All service requests should be referred to ZEVEX technical service.

## 10. WARRANTY

Solely for the benefit of the original buyer, ZEVEX INCORPORATED (“ZEVEX”), warrants all new EnteraLite Infinity products of its manufacture to be free from defects in material and workmanship, and will replace or repair, F.O.B., at its factory in Salt Lake City, Utah, or other location designated by ZEVEX, any EnteraLite Infinity products returned to it within twenty-four (24) months of original purchase by the buyer. Such repair or replacement shall be free of charge.

ZEVEX warrants to the original buyer, all repaired or replaced products to be free from defects in material and workmanship and will replace or repair such products F.O.B., at its factory in Salt Lake City, Utah, or other location designated by ZEVEX. Such repair or replacement shall carry a warranty of ninety (90) days from the date of repair or replacement or the balance of the new product warranty as described above, whichever is greater.

This Warranty applies to all EnteraLite Infinity products manufactured by ZEVEX and is the ONLY WARRANTY GIVEN FOR THE SALE OF PRODUCTS OR SERVICES. NO WARRANTIES IMPLIED IN LAW, INCLUDING, BUT NOT LIMITED TO THE IMPLIED WARRANTIES OF MERCHANTABILITY AND FITNESS FOR PARTICULAR PURPOSE, SHALL APPLY. ZEVEX WILL BE LIABLE, IN ANY EVENT, ONLY FOR THE PURCHASE PRICE OF THE DEFECTIVE PRODUCT, BUT NOT FOR ANY CONSEQUENTIAL DAMAGES.

This Warranty may not be modified, amended or otherwise changed, except by a written document properly executed by a corporate officer of ZEVEX.

ZEVEX, Inc. voids the warranty if the EnteraLite Infinity pump is opened or tampered with in any way without prior authorization from ZEVEX, Inc.

# LIST OF FIGURES

Figure	Description	Page
Figure 1-1	Pump: Front .....	1
Figure 1-2	Pump: Rear .....	2
Figure 1-3	Keypad Layout .....	3
Figure 1-4	Display Segments .....	4
Figure 1-5	Alphanumeric Characters and Units .....	4
Figure 1-6	Setting Indicators .....	4
Figure 1-7	Run Indicators .....	4
Figure 1-8	Power Indicators .....	4
Figure 1-9	EnteraLite Infinity 500ml or 1200ml Bag Set .....	5
Figure 1-10	EnteraLite Infinity Spike Set .....	5
Figure 1-11	Consult Accompanying Documents .....	6
Figure 1-12	Feeding Bag Connection .....	6
Figure 1-13	Patient Connection .....	6
Figure 1-14	TYPE BF Shock Protection .....	6
Figure 1-15	IEC 529 .....	6
Figure 1-16	Single Patient Use .....	6
Figure 1-17	DEHP-free .....	6
Figure 2-1	Spike Container .....	7
Figure 2-2	Fill Bag .....	7
Figure 2-3	Remove Cover from Barbed Adapter / Place Cover on Pole Clamp .....	7
Figure 2-4	Squeeze Bag .....	8
Figure 2-5	Pinch Tubing .....	8
Figure 2-6	Tubing Segment Being Pinched .....	8
Figure 2-7	Seat Cassette .....	9
Figure 2-8	Close Pump Door .....	9
Figure 2-9	Priming Indication .....	9



LIST OF FIGURES

---

Figure	Description	Page
Figure 2-10	Program Rate to 120 ml/hr .....	10
Figure 2-11	Program Dose to 500 ml .....	10
Figure 2-12	Clear Feed Interval .....	11
Figure 2-13	Pump is Running .....	11
Figure 2-14	Amount Currently Delivered .....	11
Figure 2-15	Total Amount Delivered .....	11
Figure 2-16	DOSE DONE .....	12
Figure 2-17	Program Rate to 50 ml/hr .....	14
Figure 2-18	Program Dose to 100 ml .....	14
Figure 2-19	Program Feed Interval 6.00 hr .....	14
Figure 2-20	Pump is Running .....	15
Figure 2-21	Amount Currently Delivered .....	15
Figure 2-22	Total Amount Delivered .....	15
Figure 2-23	Time Until Next Feeding .....	16
Figure 2-24	Battery Power Indicator .....	17
Figure 2-25	Fuel Gauge .....	18
Figure 2-28	Dose Done Settings BEEP WHEN DONE and MUTE WHEN DONE .....	19
Figure 2-26	Alarm Volume .....	19
Figure 2-27	Settings Lock UNLK and LOCK .....	19
Figure 2-29	Backlight Settings LITE OFF and LITE ON .....	19
Figure 3-1	ER01 - ER99 or ERRA - ERRZ Alarm .....	22
Figure 3-2	LOAD SET Alarm .....	22
Figure 3-3	LOW BATT Alarm .....	22
Figure 3-4	NO FLOW IN Alarm .....	23
Figure 3-5	NO FLOW OUT Alarm .....	23
Figure 3-6	NO FOOD Alarm .....	24

Figure	Description	Page
Figure 3-7	PUSH RUN TO FEED Alarm .....	24
Figure 3-8	SHUT DOOR Alarm .....	25
Figure 3-9	DOSE DONE Message .....	25
Figure 3-10	NEXT DOSE Message .....	25
Figure 3-11	CHEK Indication .....	26
Figure 3-12	Priming Indication .....	26
Figure 3-13	Battery Symbol and the E and F of the Fuel Gauge .....	27
Figure 5-1	Rinsing Pump Under Stream of Water .....	31
Figure 6-1	AC Adapter/Charger .....	32
Figure 6-2	Pole Clamp / Pole Clamp with Pump Attached to IV Pole .....	32
Figure 6-3	Adjustable Angle Pole Clamp / Adjustable Angle Pole Clamp with Pump Attached to IV Pole .....	32
Figure 6-4	Mini Backpack .....	33
Figure 6-5	Mini Backpack (Cutaway View of Internal Compartments) ...	33
Figure 6-6	Mini Backpack (Cutaway View of Internal Straps) .....	33
Figure 6-7	Super-Mini Backpack .....	33
Figure 6-8	Super-Mini Backpack (Cutaway View of Internal Compartments .....	33
Figure 6-9	Super-Mini Backpack (Cutaway View of Internal Straps) .....	33
Figure 6-10	Waist Pack .....	34
Figure 6-11	Waist Pack (Cutaway View of Internal Compartment and Straps) .....	34
Figure 6-12	Backpack .....	34
Figure 6-13	Backpack (Cutaway View of Internal Compartments) .....	34
Figure 6-14	Backpack (Cutaway View of Internal Straps) .....	34
Figure 8-1	Head Height Affect on Accuracy .....	37

---

# WHO TO CALL

## Additional Information:

YOUR HEALTHCARE PROVIDER:

---

---

---

---

---

YOUR PHYSICIAN:

---

---

---

---

---

ZEVEX Incorporated  
4314 ZEVEX Park Lane  
Salt Lake City, Utah 84123 USA  
Customer Service and Technical Support: (800) 970-2337  
[www.zevex.com](http://www.zevex.com)



# INDEX

## Symbols

+ Key 3

- Key 3

## A

**AC Adapter/Charger** 18, 32

**Accessories** 32

- AC Adapter/Charger 32
- Adjustable Angle Pole Clamp 32
- Backpack 34
- Mini Backpack 33
- Pole Clamp 32
- Super-Mini Backpack 33
- Waist Pack 34

**Accuracy** 35

**Adjustable Angle Pole Clamp** 32

**Alarms** 22, 36

- ER01 - ER99 or ERRA - ERRZ 22
- LOAD SET 22
- LOW BATT 17, 22
- NO FLOW IN 23
- NO FLOW OUT 23
- NO FOOD 24
- PUSH RUN TO FEED 24
- SHUT DOOR 25

**Alarm Volume** 19

## B

**Backpack** 34

**Battery** 17

- AC Adapter/Charger 18
- Battery Life 17
- Battery Symbol 17
- Charge Time 17
- Charging the Battery 18
- Fuel Gauge 17

LOW BATT Alarm 17

Plug Symbol 18

Running on Battery Power 17

**Blockage.** See **Occlusion (Blockage)**

## C

**Carry Packs** 33

**Classification Information** 36

**Cleaning** 31

- Acceptable Cleaners/Disinfectants 31
- To clean the AC Adapter/Charger 31
- To clean the Carrying Packs 31
- To clean the EnteraLite Infinity Enteral Feeding Pump 31
- Unacceptable Cleaners/Disinfectants 31

**CLEAR Key** 3

**Compact Wall Charger.** See **AC Adapter/Charger**

## D

**Decrease (-) Key.** See **- Key**

**Directions for Use** 7

- Loading the Disposable Set 7
- Priming the Disposable Set 7
- Removing Air 7

**Display** 4

- Battery Symbol 4
- Display Light 4
- Fuel Gauge Symbol 4
- Run Symbol 4
- Wall Plug Symbol 4

**Disposable Set** 5

- 1200 ml Bag Set 5
- 500 ml Bag Set 5
- Adapter Protective Cover 5, 7
- Barbed Enteral Adapter 5, 7
- Cassette 5

Downstream Tubing 5  
Features 35  
Spike 5  
Spike Protective Cover 5  
Spike Set 5  
Upstream Tubing 5

**Disposable Set Displacement 39**

**Dose 10, 14, 35**

## E

**Electromagnetic Emissions/Interference 38**

## F

**Feeding Completion 12, 16**

**Feeding Example (Interval Feeding) 13**

**Feeding Example (Single Feeding) 10**

**Feed Interval 3, 25, 26, 35**

**FEED INT Key 3**

**Flow Rate 10, 14, 35, 37**

**Foam 7, 24**

**Free-flow 35**

**Fuel Gauge 4, 18**

## I

**Increase (+) Key. See + Key**

**Indications 26**

Battery Doesn't Charge 27  
Battery Doesn't Hold Its Charge 27  
Charger Installed but No Plug Symbol Visible 27  
CHEK 26  
TO STOP LET GO 9, 26

**Infinite Dose 12**

**Instructions for Use 7**

Loading the Disposable Set 7

Priming the Disposable Set 7

Removing Air 7

**Interval Feeding Example 13**

## K

**Keypad 3**

+ Key 3

- Key 3

CLEAR Key 3

FEED INT Key 3

ON/OFF Key 3

PRIME Key 3

RATE/DOSE Key 3

RUN/PAUSE Key 3

VOL/TOTAL Key 3

## L

**Less (-) Key. See - Key**

**Lock Settings. See Settings Lock**

## M

**Maintenance 39**

**Messages 25**

DOSE DONE 12, 25

NEXT DOSE 25

**Mini Backpack 33**

**More (+) Key. See + Key**

## N

**New Feeding Cycle 16**

**Next Feeding 13**

## O

**Occlusion (Blockage)** 23, 36  
**ON/OFF Key** 3  
**Operating Environment** 36  
**Operating Orientation** 35

## P

**Pediatric Considerations** 37  
**Pole Clamp** 2, 7, 32  
**Prime Feature** 3, 8, 9, 26  
**PRIME Key** 3, 9, 26  
**Program Memory** 12, 16, 35  
**Pump Components** 1

- Air Sensor 1
- Charger/Power Connector 2
- Display 1
- Door 1
- Downstream Pressure Sensor 1
- Keypad 1
- Pump Instruction Label 2
- Pump Wheel 1
- Receptacle for Cassette 1
- Receptacle for Pole Clamp 2
- Serial Number Label 2
- Speaker 2
- Upstream Pressure Sensor 1

## R

**RATE/DOSE Key** 3  
**Rinse** 31  
**RUN/PAUSE Key** 3

## S

**Self Test** 9

**Serial Number** 2, 9  
**Settings Lock** 19  
**Single Feeding Example** 10  
**Size (Pump Specifications)** 35  
**Software Revision** 9  
**Storage Environment** 36  
**Super-Mini Backpack** 33  
**Symbols** 6

## T

**Troubleshooting Guide** 28

- Charging Problems 30
- LOAD SET Alarm 29
- NO FLOW IN or NO FLOW OUT Alarms 29
- NO FOOD Alarm 28

## U

**User Preference Settings** 19

- Adjusting User Preference Settings 20
- Alarm Volume 19
- Backlight 19
- Dose Done 19
- Settings Lock 19

## V

**VOL/TOTAL Key** 3, 11, 15

## W

**Waist Pack** 34  
**Warranty** 40  
**Water** 31

---

# NOTES



---

# NOTES



EnteraLite® *Infinity*®  
ENTERAL FEEDING PUMP

# OPERATOR'S MANUAL

Also available in other languages

## ZEVEX®

4314 ZEVEX Park Lane  
Salt Lake City, Utah 84123 USA  
toll free: (800) 970-2337  
tel: (801) 264-1001  
fax: (801) 264-1051  
www.zevex.com

**NASDAQ: ZVXI**

© 2007 ZEVEX Incorporated. **Made in USA.**

Covered under one or more of the following US Patent No's 5,267,983, 6,523,414, 6,531,708, 6,595,950, 6,623,447, 6,659,976, 6,685,670, 6,750,468, 6,852,094, 6,907,788, 6,923,785, D455,489, D501,924, D503,799, D503,978, D504,506, D505,199 and D507,647 and Foreign Patent No's 40108978.9, 40209539.1, 40302879.5, ZL 01338370.1, ZL 02369422.4, 03306228.5, 015998, 701976-701985, 16,112, 2104612, 3012123, 3010564, 129,165, 129,630 and 241366. Other US and Foreign patents pending. EnteraLite, Infinity, and ZEVEX are registered trademarks of ZEVEX Incorporated.

25356-001 Rev. D



## **Addendum**

to

**EnteraLite® Infinity® Operator's Manual**

**Part Number 25356-001**

**Revisions A thru H**

**"Use ONLY commercially available pre-packed or commercially prepared feeding solutions formulated for use with a feeding pump that are prescribed by a licensed health care provider, dietician or nutritionist. DO NOT USE HOMEMADE BLENDERIZED OR LIQUIDIZED FOODS, OR OTHER NON-PRESCRIBED, NON-COMMERCIALY AVAILABLE FEEDING SOLUTIONS. Use of homemade, blenderized or liquidized foods or other non-prescribed feeding solutions may cause sticky solids which could cause an obstruction of the optical sensor. It is recommended that all users clean and maintain the pump and optical sensors according to manufacturer's recommendations.**

**The Infinite Dose or Interval Feeding programming option listed in the operator's manual should NOT be used for seriously health compromised patients and children, or patients who are extremely sensitive to receiving air in the stomach with an enteral feeding. It is recommended that a single feeding regimen for specific dose be used for this particular user group."**